

# Data Sheet



Article number: 339707510000

Description: Multibeam 6 Coupling 707.51.0000  
Aluminium relieved & clamp hubs

## Measures

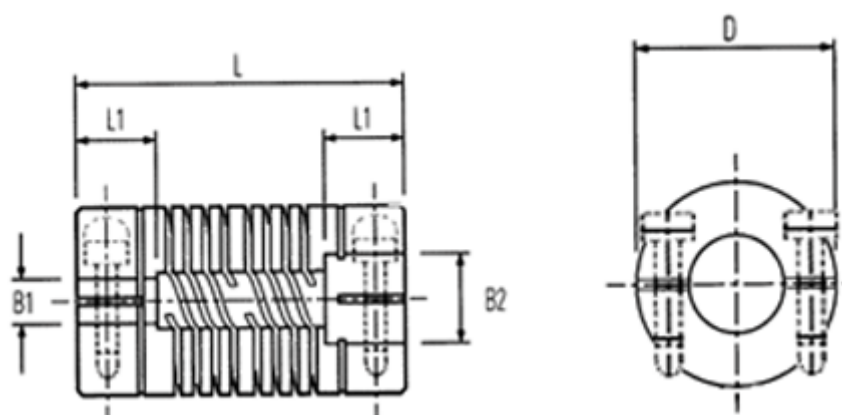

B2: Pre-drilled	= 10.0
B2: Pre-drilled	= 16.00
Cap screw	= M6
D	= 50.8
L	= 95.3
L1	= 25.0
Max angular displacement	= 0.90
Max B1 & B2	= 26.00

Max parallel displacement	= 7
Peak Torque NM	= 40.00